

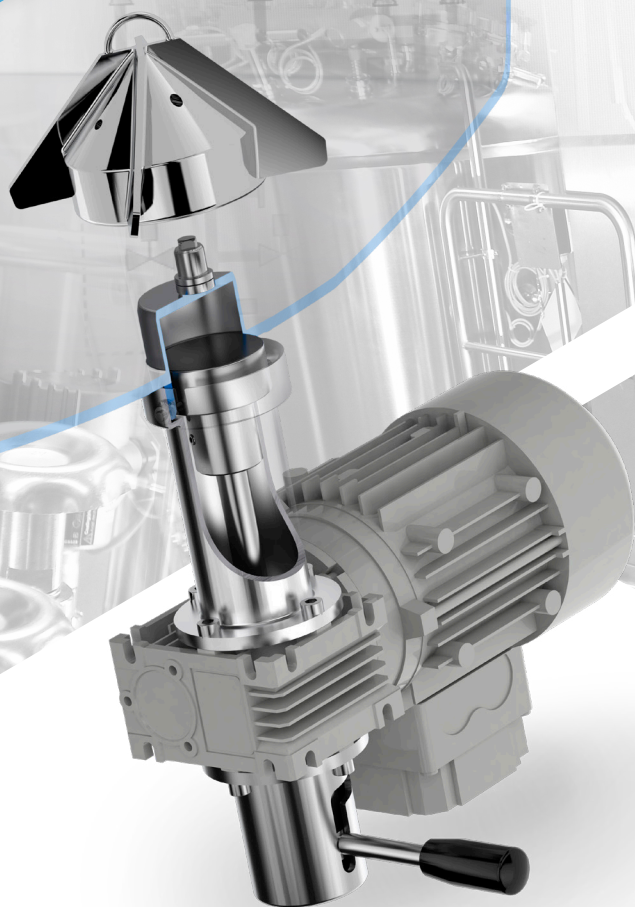

PROVEN EXPERTISE

Serving the pharmaceutical industry



Sterimixer®
Magnetic coupled mixers

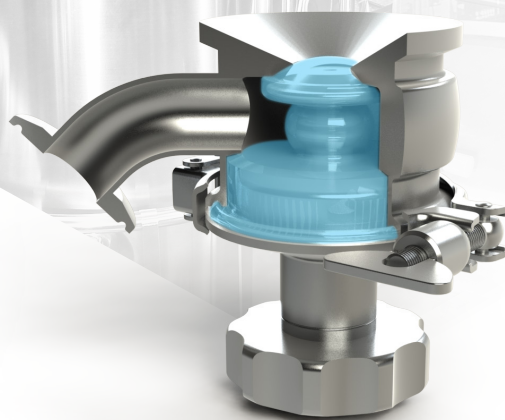

Sterivalve®
Valves designed for sterile processes



Did you know?

Steridose is represented in important certifying and standards organizations, most notably and relevant to the pharmaceutical industry, ASME BioProcessing Equipment standards committee (BPE).

GMP and Change control

In a recent survey, 46% of respondents indicated they experienced quality problems caused by poor vendor change control. About the same number complained about poor vendor change notification. We take change control very seriously and will continue to do so because we know it's paramount to safeguard the process and its output.

In the beginning there was...

Magnetically coupled mixers had existed for years, when more than 30 years ago, Steridose became the first manufacturer to apply and fine-tune the technology for the biopharmaceutical industry. The unique requirements associated with aseptic process design were used to create specialized product ranges such as the Sterimixer and the Sterivalve. We have thousands of installations in countries throughout the world, as well as a product range that continues to grow through innovations and additions to suit even more processes and industries.

Nothing has changed... or has it?

The advantages of magnetically coupled mixers over mixers with a shaft that penetrates the vessel still hold true: by eliminating the need for a mechanical seal and a rotating shaft through the vessel wall, we eliminate the risk for contamination and leakages therefore, the process is contained and isolated. Basically, what's in stays in and, what's out stays out! What has changed is that this type of containment and isolation is beneficial to many more processes and industries than it was only a decade ago.

The perfect mix...

We partner with the best distributors and representatives in the industry, all over the world. Together we become the perfect mix; a premium product with global references, combined with a local presence for product and application support.

The mysteries of mixing

Pumping rate, tank turnovers and blend time

A mixer's capability is often defined by its ability to provide the required pumping capacity (volume per minute). The pumping rate divided by the tank volume equals the number of times the contents of the tank have been recirculated per minute, known as 'tank turnovers'. The blend time is the number of minutes required to recirculate the contents of the tank X times (with X determined by application and experience).

Flow vs Shear

Each mixer impeller's design generates a unique flow pattern that, combined with the flow regime, will determine the level of pumping and shear that it can impart to the liquid. High pumping, low shear impellers are used for shear sensitive applications (such as cell culture) and general blending. Low pumping, high shear impellers are used to create emulsions, and incorporate powders that tend to float or agglomerate.

Viscosity

Viscosity is a property of fluids that characterizes their resistance to flow. A higher viscosity fluid is more difficult to pump than a lower viscosity fluid, leading to longer blend times. Some fluids "act" less viscous when shear is applied to them. This is often referred to as the apparent viscosity of a fluid.

Vortex or not?

A vortex is a flow pattern formed by the mixer for the purpose of drawing down solids that would otherwise float. In a great number of cases, a vortex is not desirable because it can result in air entrainment and incomplete mixing.

Shaken or stirred?

The terms "mixing" and "agitation" are sometimes used interchangeably. Mixing, refers to the ability to mix the components on a microscopic level, often called micromixing. Agitation, describes fluid that is in motion, not necessarily mixing (macromixing).

For successful mixing, we need both - micromixing (shaken) and macro-mixing (stirred) to get the mixing action throughout out the tank!

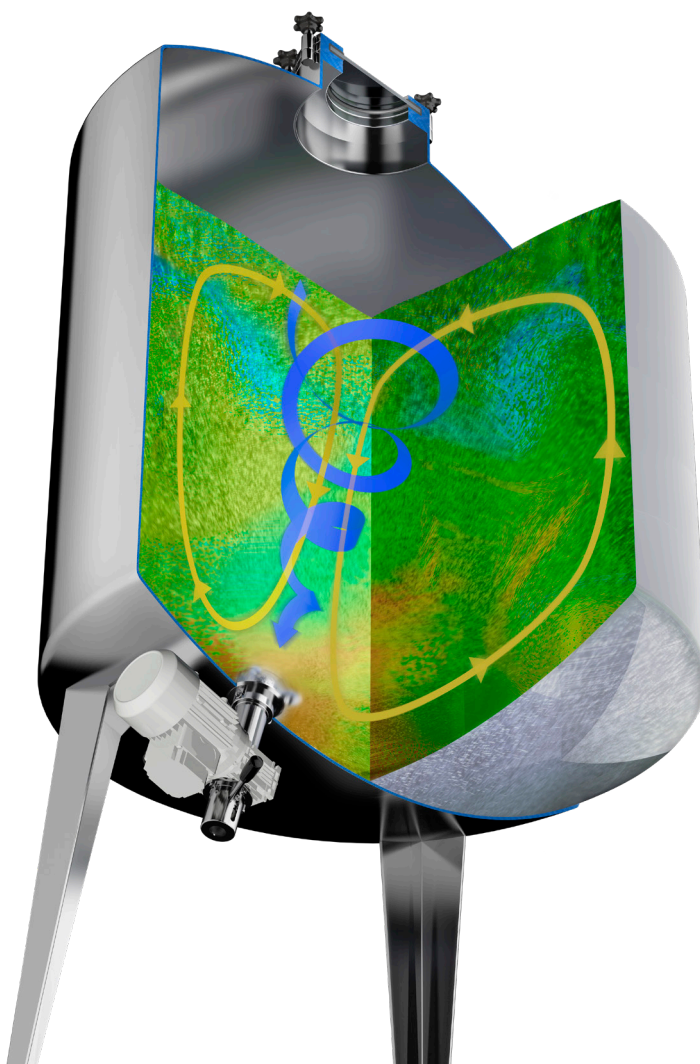

Agitation

What applications can be addressed by a Sterimixer?

In a biopharmaceutical plant, Sterimixers can be found in upstream, downstream and fill & finish applications.



- Storage
- Heat transfer
- Mixing miscible liquids
- Dissolving solids in liquid
- Suspensions
- Dissolving gas in liquid

Why choose a mag mixer?

Containment and isolation: the proven magnetic coupling (no shaft or mechanical seal) means, what's in stays in and what's out stays out!

Mixing to the last drop: a bottom mount mixer reduces the minimum mixing volume to nearly nothing.

No baffles: the off-center installation eliminates the need for difficult-to-clean baffles.

Cleaning: this is straight-forward using Cleaning-in-Place (CIP) and Sterilization-in-Place (SIP).

Compact design: no overhead equipment needed; the mixer is installed safely on the bottom.

Maintenance: easy impeller removal, easy drive unit removal using a bayonet coupling or magnet lowering device.

Gas entrainment and foaming: this is greatly reduced by having the impeller on the bottom.

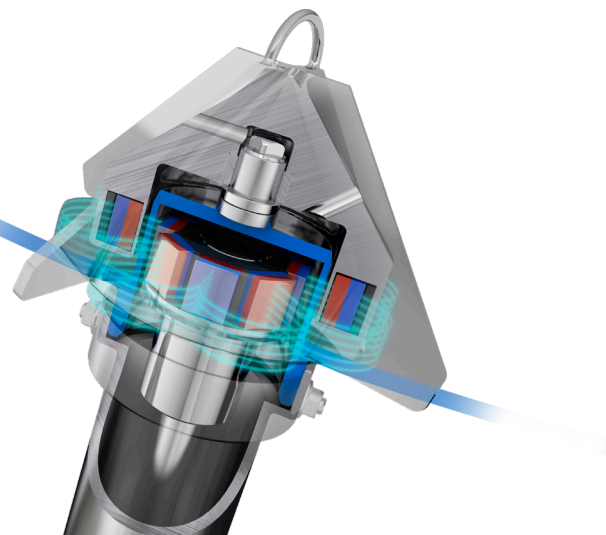

Sterimixer SMA, SMO and SMMS

Interchangeability

The Sterimixer has some built-in flexibility to handle changes in your process. For example, all Sterimixers with the number “85” in the model designation are interchangeable on the same weld plate. In some cases, even the medium shear SMMS can be retrofitted onto a weld plate that is common to the SMA and SMO.

SMA and SMO - Sterimixer can be selected with low-shear SMO or SMA impellers, or with medium-shear SMMS impellers. SMA type of impeller is optimized for cleaning in-place while submerged in cleaning liquid, which improves cleanability in applications that use liquids with ‘sticky’ properties. SMO type of impellers are optimized for in-tank spray-ball cleaning and do not require submergence.



SMA



SMO

Model:	60/75	85/100	85/140	120/150	120/190	120H/220	120H/260	210/275	210/350
SMA	•	•	•	•	•	•	•	•	•
SMO		•	•	•	•	•	•	•	•
Speed (rpm)	50 - 450 rpm (VFD 5 - 90 Hz)				50 - 350 rpm (VFD 5 - 90 Hz)				
Magnetic coupling (Nm/in-lb)	0.75 / 6.6	2.3 / 20	2.3 / 20	14 / 124	14 / 124	26 / 230	26 / 230	38 / 336	38 / 336
Motor Power (W/HP)	75 / 0.1	180 / 0.25	180 / 0.25	750 / 1.0	1100 / 1.5	1500 / 2	1500 / 2	2200 / 3	3000 / 4
Lowering device	No	Optional							

Magnet lowering device (LD)

The magnetic coupling is difficult to break without damaging the bearings therefore, in conventional installations, the drive unit should be completely removed from the tank before removing/installing the impeller, not vice-versa. The Steridose magnet lowering device allows the user to break the magnetic coupling without removing the drive unit from the vessel. This is a significant ergonomic enhancement that greatly reduces service time and is particularly useful when working with heavy drive units that can weigh as much as 45 kg (100 lbs). Existing drive units can be retrofitted with this feature in the field.



SMMS - Medium shear mixers are suitable for applications such as incorporating powders that are difficult to wet.

Model SMMS :	85	120
Speed (rpm)	50 - 1200 rpm (5 - 40 Hz)	50 - 1800 rpm (5 - 60Hz)
Magnetic coupling (NM/in-lb)	2.3 / 20	14 / 125
Motor Power (W/HP)	550 / 0.75	3 000 / 4



Quick selection chart

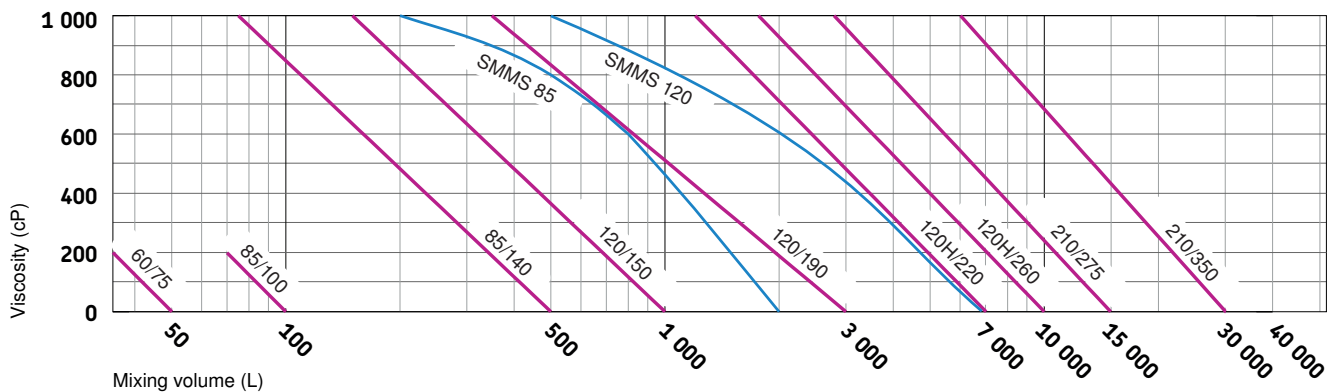

Specifications

- Design and materials in accordance with industry requirements (i.e. FDA, ASME BPE, GMP).
- Full traceability of process-contact components (EN 10204 3.1 certificates included).
- All process-contact stainless steel parts in AISI 316L (EN 1.4404), other alloys (e.g. AL6XN, Hastelloy) on request.
- Surface finish better than Ra 0.38 μm (15 μin) electropolished ASME BPE SF4.
- Bearing materials (USP <87>) options: Tungsten Carbide, Silicon Carbide, Dri-amond™ (diamond coated silicon carbide).
- Elastomer (USP <88> class VI) options: Viton, EPDM, other materials on request.
- Clean-In-Place and Steam-In-Place capable.
- Tank diameter: liquid height-ratio: from 1:1 to 1:2.
- Motor options: Explosion-proof motors, air motors, stainless steel motors.
- Monitoring and control: VFD control boxes and optional Impeller Monitor Sensor available (a positive way of determining actual impeller speed or, if the impeller has become decoupled).

Sanimixer

The Sanimixer magnetic coupled mixer is the cost-effective alternative for highly demanding food, beverage, dairy, cosmetic and high purity chemical applications. It guarantees that your product will not get out (containment) and contaminants will not get in (isolation). The Sanimixer has all of the features and benefits of the Sterimixer, which has proven itself in pharmaceutical applications for over 30 years and in thousands of installations worldwide. The Sanimixer is manufactured specifically to address the requirements of sanitary industries that are not as stringent as the pharmaceutical industry. It is available in sizes up to 30 000 L (8 000 US gal) general mixing, or 40 000 L (10 500 US gal) gentle mixing.



Sanimixer	500	3000	10 000	30 000
Speed (rpm)	50 - 450 rpm (VFD 5 - 90 Hz)		50 - 350 rpm (VFD 5 - 90 Hz)	
Magnetic coupling (Nm/in-lb)	2.3 / 20	14 / 124	26 / 230	38 / 336
Motor Power (W/HP)	180 / 0.25	1 100 / 1.5	1 500 / 2	3 000 / 4

Quick selection chart

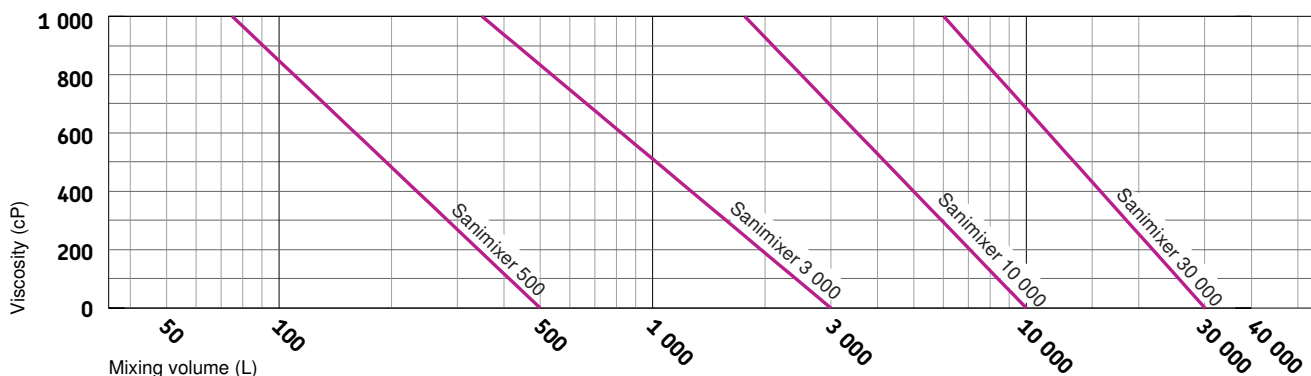

Specifications

- Design and materials in accordance with FDA requirements.
- All process-contact stainless steel parts in AISI 316L.
- Surface finish better than Ra 0.8 μm (32 μin).
- Bearing material: Tungsten Carbide.
- Clean-In-Place and Steam-In-Place capable.
- Tank diameter: liquid height-ratio: from 1:1 to 1:2.
- Explosion proof motors, stainless steel motors.
- Statement of Compliance (EN10204 2.1).

Sterivalve - Unique aseptic design

The Sterivalve range provides high performance flow control for pharmaceutical and biopharmaceutical liquid process. Its hydrodynamically optimized design ensures that the Sterivalve offers low flow resistances with a proven hygienic design.

All moving parts in the actuator are completely isolated from contact with the process fluids.

Steridose range of aseptic valves, Sterivalve, have proven themselves for decades. They are available in sizes 12 (1/2"), 25 (1"), 38 (1 1/2"), 51 (2") and 76 (3") and in many configurations.

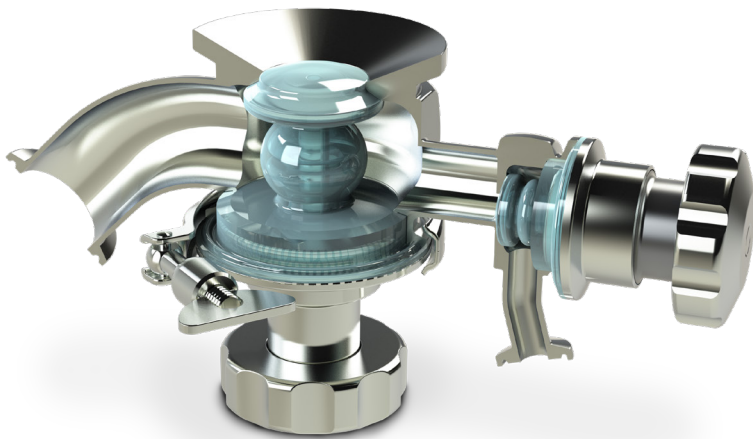
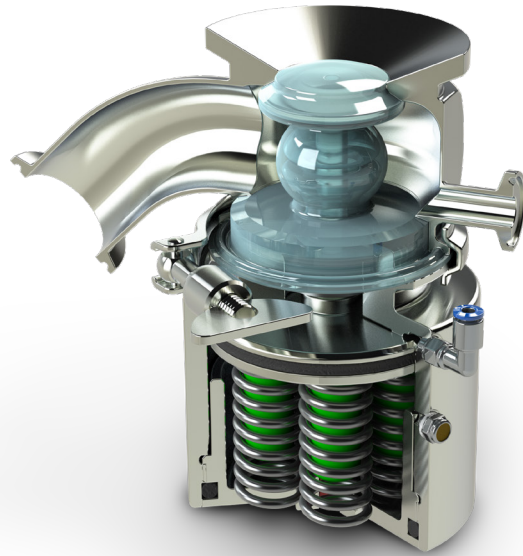

Specifications:

Design and materials in accordance with industry requirements (i.e. FDA, ASME BPE, GMP)

- Full traceability of process-contact components (EN 10204 3.1 certificates included).
- All process-contact stainless steel parts in AISI 316L (EN 1.4404), other alloys on request.
- Surface finish better than Ra 0.38 µm (15 µin) electropolished ASME BPE SF4.
- Diaphragm options: Silicone, EPDM or PTFE (all USP <88> class VI).

Features:

- Flush sealing, self-draining and no dead legs.
- Wide range of configuration options, e.g. weld-nose or TC connections, 90-degree, 45-degree, etc.
- Clean-In-Place and Steam-In-Place capable.
- Only process-contact components are the valve housing and the diaphragm.
- Can be equipped with manual or pneumatic actuators.
- Actuators can be fitted with sensors to be included in the plant's monitoring & control systems (support for most automation suppliers).

Valve Configurations

Tank bottom outlet valves



Single outlet



Double outlet



Single outlet
with side port



Single outlet
with satellite valve

Process valves



Shut-off



Flow-through



Divert



Take-off

Diaphragm materials



Silicone



EPDM



PTFE

Actuator options



Stainless Steel - Manual



Stainless Steel – Pneumatic

About us

Steridose is a global brand manufactured at the IDEX Material Processing Technologies plant in Canada. We are highly specialized in the design, development and manufacturing of magnetic coupled mixers and radial diaphragm valves.

Steridose is part of IDEX Corporation, with regional offices in key locations around the world.

Steridose is represented in important certifying and standards organizations, most notably and relevant

to the pharmaceutical industry, ASME BioProcessing Equipment standards committee (BPE). We help develop the standards and Good Manufacturing Practices that minimize risk for process interference.

Steridose partners with the best distributors and representatives in the industry all over the world. Together we become the perfect mix; a premium product with global references combined with local presence for product and application support.

Why partnering with Steridose

We are responsive to End-users, OEMs and Engineering firms

Recognize the different needs, wants and pain points

We have a proven design

'It works', over 10,000 units worldwide

We have knowledge of the industry

We know bioprocess

We are close to our customers

Local reps, distributors, stock



Steridose Selection Tool and Information Resource

STIR – 40 years of mixing expertise at your fingertips

We are making our tools public available, greatly simplifying Steridose mixer selection and putting all the relevant information and performance right at your fingertips.

STIR will take a few of your application's parameters and provide you with a mixer selection, performance parameters and the option of creating a one-page PDF with the selection result.

To use STIR, navigate to:



www.steridose.com/stir

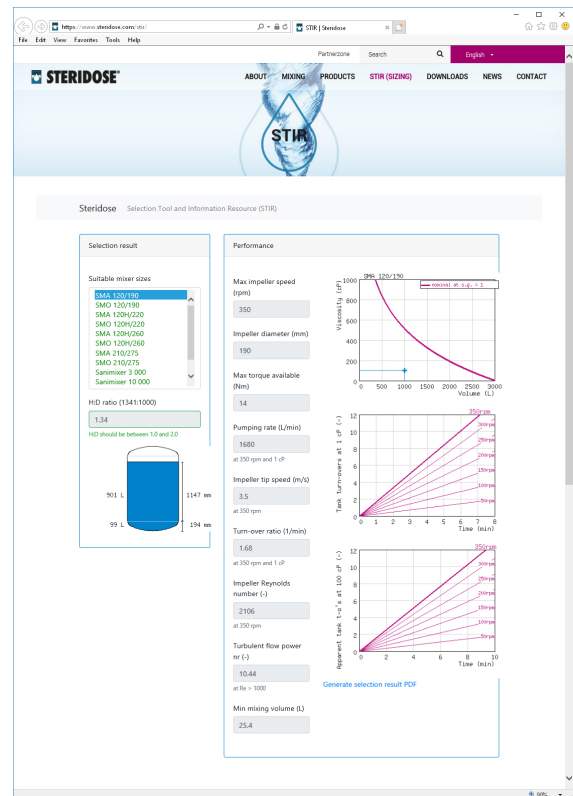

Manufacturing site & regional office:
 IDEX Material Processing Technologies
 613 Colby Drive
 Waterloo, Ontario
 N2V 1A1 Canada
 +1 (519) 884 9660
 info@steridose.com

Regional office:
 Steridose
 Ostmastargrand 8A
 12040, Stockholm
 +46 8 449 9900
 info@steridose.com

www.steridose.com



Material Processing
 Technologies